

3V1 Series Solenoid Valve

Ordering Code

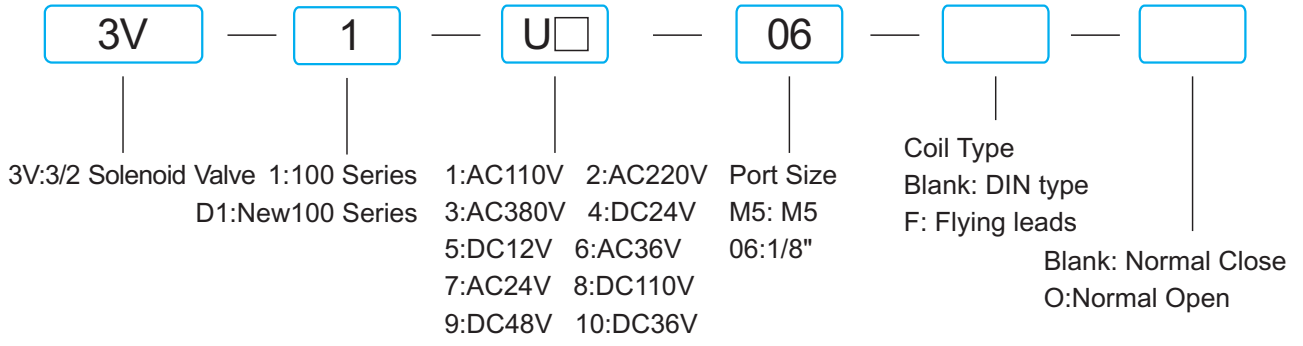

Directional Valve

Specifications

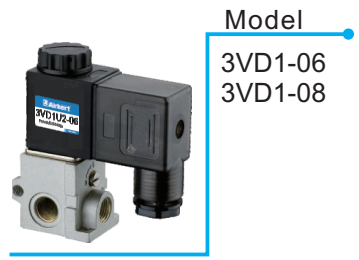
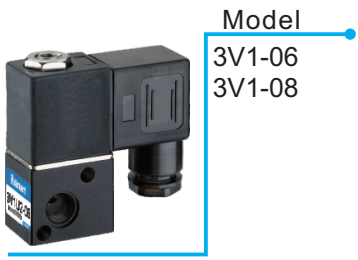





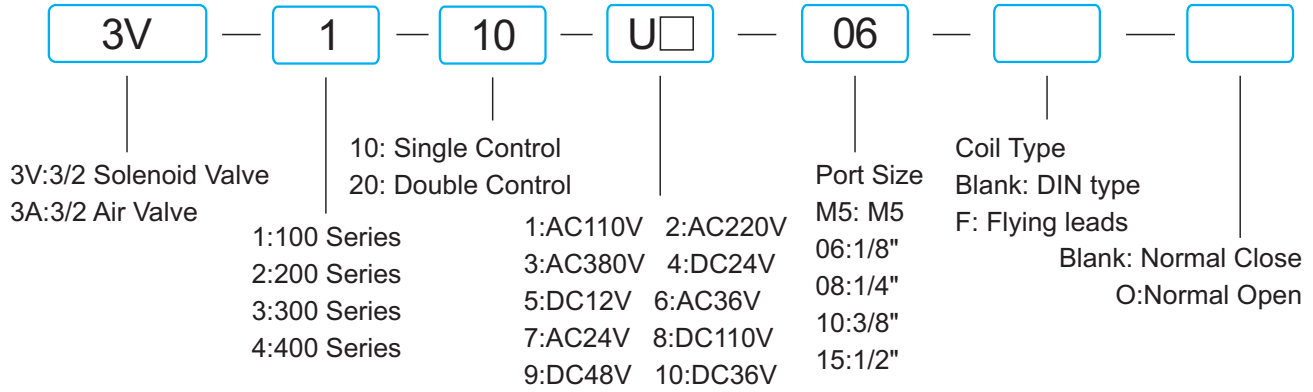



3V Series Solenoid Valve

Ordering Code



Directional Valve

Specifications

 <p>Model 3V110-M5 3V110-06</p>	 <p>Model 3V210-06 3V210-08 3V310-08 3V310-10 3V410-10 3V410-15</p>	 <p>Model 3V120-M5 3V120-06</p>	 <p>Model 3V220-06 3V220-08 3V320-08 3V320-10 3V420-10 3V420-15</p>
 <p>Model 3A110-M5 3A110-06 3A210-06 3A210-08 3A310-08 3A310-10 3A410-10 3A410-15</p>	 <p>Model 3A120-M5 3A120-06 3A220-06 3A220-08 3A320-08 3A320-10 3A420-10 3A420-15</p>	 <p>Model 3V1-NF 3V2-NF 3V3-NF 3V4-NF (N=1.2.3...14)</p>	 <p>3V Series Valve Block</p>

4V Series Solenoid Valve

Ordering Code

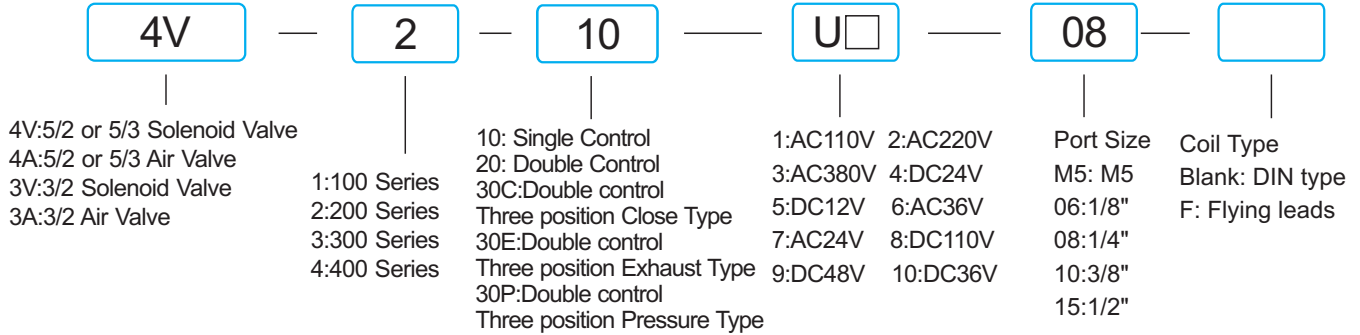

Directional Valve

Specifications(5/2)

 Model 4V110-M5 4V110-06	 Model 4V210-06 4V210-08 4V310-08 4V310-10	 Model 4V410-10 4V410-15	 Model 4V120-M5 4V120-06
 Model 4V220-06 4V220-08 4V320-08 4V320-10 4V420-10 4V420-15	 Model 4V420-10 4V420-15	 Model 4A110-M5 4A110-06 4A210-06 4A210-08 4A310-08 4A310-10	 Model 4A410-10 4A410-15
 Model 4A120-M5 4A120-06 4A220-06 4A220-08 4A320-08 4A320-10	 Model 4A420-10 4A420-15	 Model 4V1-NF 4V2-NF 4V3-NF 4V4-NF (N=1.2.3...14)	

Specifications(5/3)

 Model 4V120-M5C 4V120-06C 4V120-M5P 4V120-06P 4V120-M5E 4V120-06E	 Model 4V230-06C 4V330-08P 4V230-08C 4V330-10P 4V330-08C 4V230-06E 4V330-10C 4V230-08E 4V230-06P 4V330-08E 4V230-08P 4V330-10E	 Model 4V430-10C 4V430-15C 4V430-10P 4V430-15P 4V430-10E 4V430-15E
 Model 4A120-M5C 4A120-06C 4A120-M5P 4A120-06P 4A120-M5E 4A120-06E	 Model 4A430-10C 4A430-15C 4A430-10P 4A430-15P 4A430-10E 4A430-15E	 Model 4A230-06C 4A230-06E 4A230-08C 4A230-08E 4A330-08C 4A330-08E 4A230-06P 4A230-06E 4A230-08P 4A230-08E 4A330-08P 4A330-08E 4A230-10P 4A330-10E 4A330-10P

4M Series Namur Valve

Ordering Code



4M:5/2 or 5/3 Solenoid Namur Valve
 4AM:5/2 or 5/3 Air Namur Valve
 3M:3/2 Namur Solenoid Valve
 3AM:3/2 Air Namur Valve

1:100 Series
 2:200 Series
 3:300 Series
 4:400 Series

10: Single Control
 20: Double Control
 30C: Double control
 Three position Close Type
 30E: Double control
 Three position Exhaust Type
 30P: Double control
 Three position Pressure Type

1:AC110V 2:AC220V
 3:AC380V 4:DC24V
 5:DC12V 6:AC36V
 7:AC24V 8:DC110V
 9:DC48V 10:DC36V

Port Size Coil Type
 M5: M5 Blank: DIN type
 06: 1/8" F: Flying leads
 08: 1/4"
 10: 3/8"
 15: 1/2"

Directional Valve

Namur Solenoid Valve

Model
 4M110-M5
 4M110-06

Model
 4M210-06
 4M210-08
 4M310-08
 4M310-10
 4M410-10
 4M410-15

Model
 4M120-M5
 4M120-06

Model
 4M220-06
 4M220-08
 4M320-08
 4M320-10
 4M420-10
 4M420-15

Model
 3M110-M5
 3M110-06

Model
 3M210-06
 3M210-08
 3M310-08
 3M310-10
 3M410-10
 3M410-15

Model
 4M130-M5C 4M130-M5P 4M130-M5E
 4M130-06C 4M130-06P 4M130-06E
 4M230-06C 4M230-06P 4M230-06E
 4M230-08C 4M230-08P 4M230-08E
 4M330-08C 4M330-08P 4M330-08E
 4M330-10C 4M330-10P 4M330-10E
 4M430-10C 4M430-10P 4M430-10E
 4M430-15C 4M430-15P 4M430-15E

Namur Air Valve

Model
 3AM110-M5 3AM310-10
 3AM110-06 3AM410-10
 3AM210-06 3AM410-15
 3AM210-08
 3AM310-08

Model
 4AM110-M5 4AM310-10
 4AM110-06 4AM410-10
 4AM210-06 4AM410-15
 4AM210-08
 4AM310-08

Model
 4AM120-M5 4AM320-10
 4AM120-06 4AM420-10
 4AM220-06 4AM420-15
 4AM220-08
 4AM320-08

Model
 4AM130-M5C 4AM130-M5P 4AM130-M5E
 4AM130-06C 4AM130-06P 4AM130-06E
 4AM230-06C 4AM230-06P 4AM230-06E
 4AM230-08C 4AM230-08P 4AM230-08E
 4AM330-08C 4AM330-08P 4AM330-08E
 4AM330-10C 4AM330-10P 4AM330-10E
 4AM430-10C 4AM430-10P 4AM430-10E
 4AM430-15C 4AM430-15P 4AM430-15E

VF Series Solenoid Valve

Ordering Code

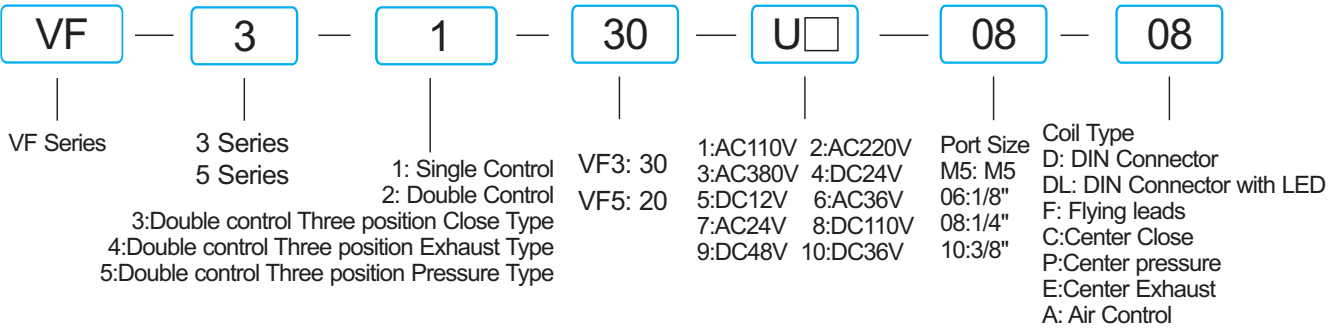

Directional Valve

Specifications



Model
VF3130-06F
VF3130-08F
VF5210-08F
VF5210-10F



Model
VF3130-06D
VF3130-08D
VF5210-08D
VF5210-10D



Model
VF3130-06DL
VF3130-08DL
VF5210-08DL
VF5210-10DL



Model
VF3230-06F
VF3230-08F
VF5220-08F
VF5220-10F



Model
VF3230-06D
VF3230-08D
VF5220-08D
VF5220-10D



Model
VF3230-06DL
VF3230-08DL
VF5220-08DL
VF5220-10DL



Model
VF3330-06/08FC
VF3430-06/08FE
VF3530-06/08FP
VF5320-08/10FC
VF5420-08/10FE
VF5520-08/10FP



Model
VF3330-06/08DC
VF3430-06/08DE
VF3530-06/08DP
VF5320-08/10DC
VF5420-08/10DE
VF5520-08/10DP



Model
VF3330-06/08DLC
VF3430-06/08DLE
VF3530-06/08DLP
VF5320-08/10DLC
VF5420-08/10DLE
VF5520-08/10DLP



Model
VFA3130-06
VFA3130-08
VFA5210-08
VFA5210-10



Model
VFA3230-06
VFA3230-08
VFA5220-08
VFA5220-10



Model
VF3-NF
VF5-NF
(N=1.2.3...14)

Hand Pull/Push/Foot Valve

Hand Pull Valve

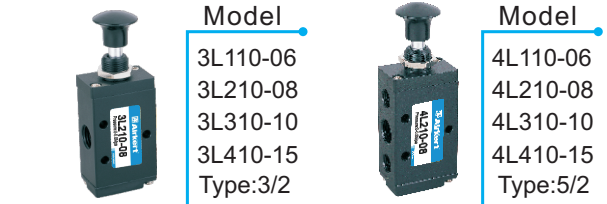
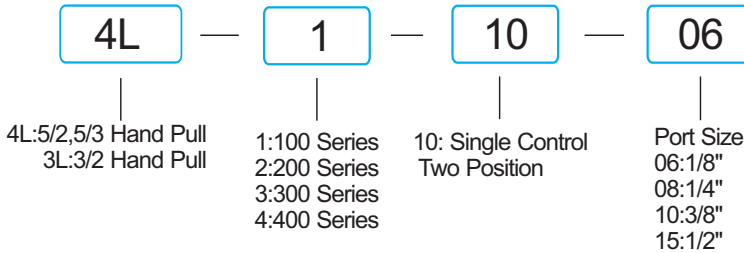

Hand Push Valve

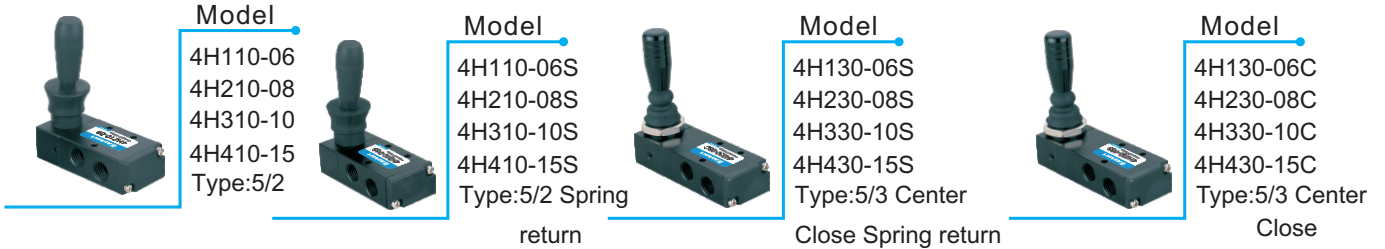
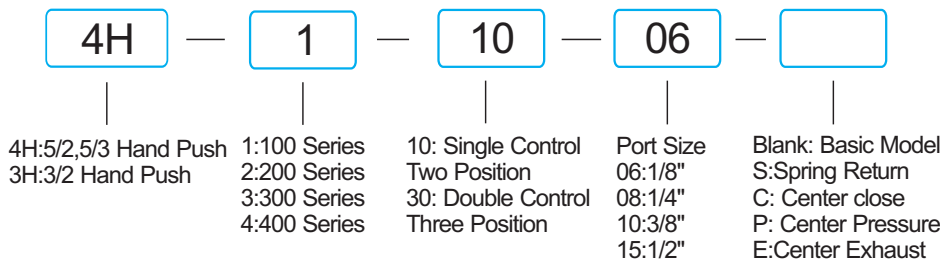

Foot Valve

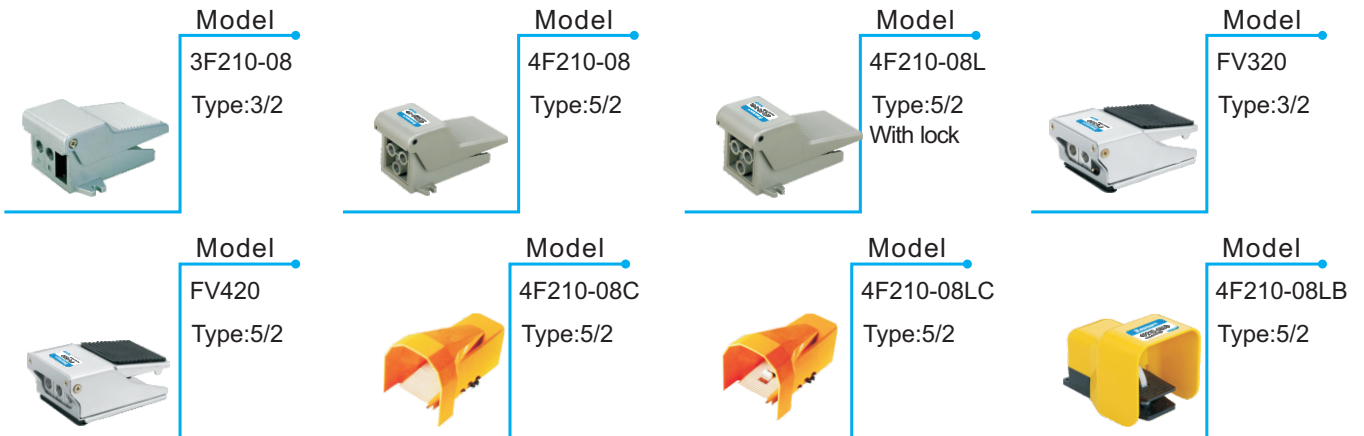
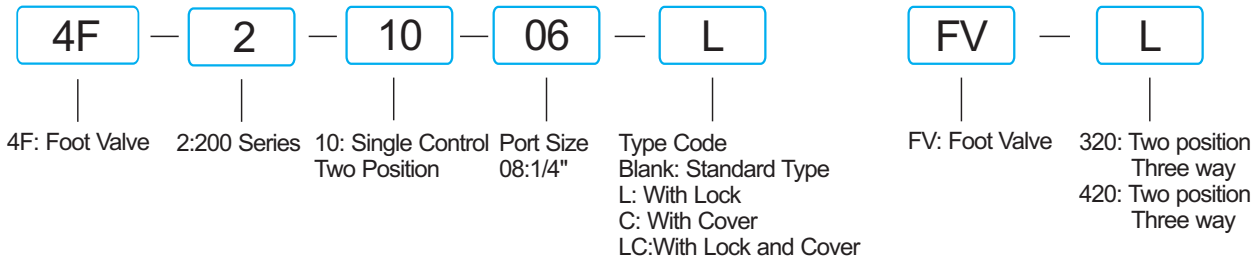

Other Valves

Rotary valve



Model
MV200 1/4"



Model
UV200 1/4"



Model
RV200 1/4"
RV300 3/8"
RV400 1/2"



Model
MR200 1/4"
MR300 3/8"
MR400 1/2"

Flow Control valve



Model
FC-01 1/8"
FC-02 1/4"
FC-03 3/8"
FC-04 1/2"



Model
BFC-01 1/8"
BFC-02 1/4"
BFC-03 3/8"
BFC-04 1/2"

Shuttle valve



Model
ES-06 1/8"
ES-08 1/4"
ES-10 3/8"
ES-15 1/2"
ES-20 3/4"
ES-25 1"

Quick exhaust valve



Model
KKP-06 1/8"
KKP-08 1/4"
KKP-10 3/8"
KKP-15 1/2"
KKP-20 3/4"
KKP-25 1"

One way valve



Model
EA-06 1/8"
EA-08 1/4"
EA-10 3/8"
EA-15 1/2"
EA-20 3/4"
EA-25 1"

Slide valve



Model
SV-06 1/8"
SV-08 1/4"
SV-10 3/8"
SV-15 1/2"
SV-20 3/4"
SV-25 1"

Valve Kits

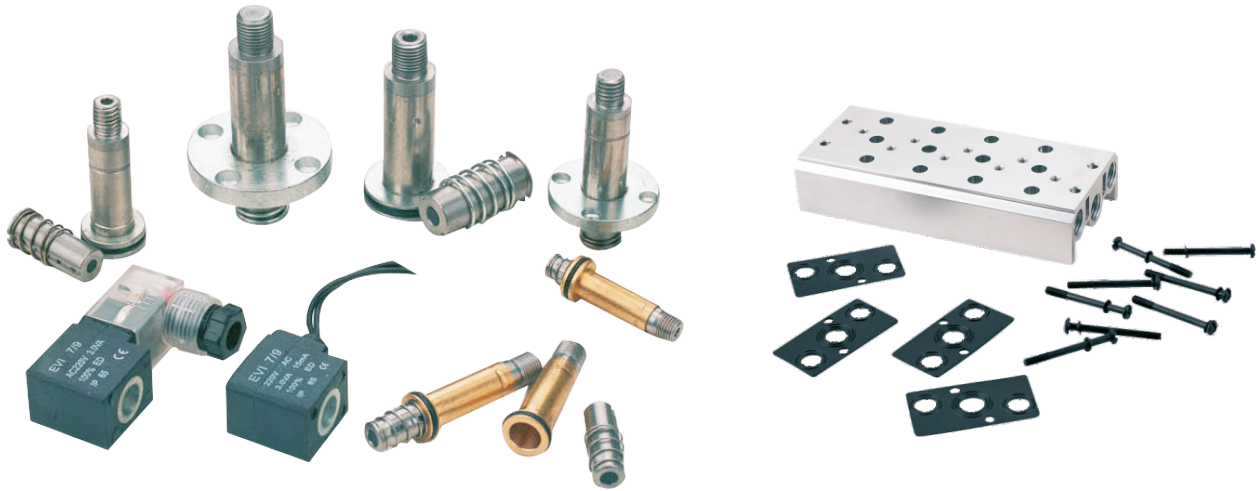

Replacement valve kits are available which contain common maintenance items that may be needed during the life of the valves.
We also can provide special kits according to clients' requirement.



Pneumatic Accessories

M221 Series



M221-S1



M221-S2



M221-S3



M221-S5



M221-S6



M221-S7

Valves

M322 Series



MJ322-S1



MJ322-S2



MJ322-S3



MJ322-S4



MJ322-S5



MJ322-S6



MJ322-S7

MJ322 SERIES



M322-S1



M322-S2



M322-S3



M322-S4



M322-S5



M322-S6

M522 Series



M522-S1



M522-S2



M522-S3



M522-S4



M522-S5



M522-S6



M522-S7